

P-Channel Enhancement Mode MOSFET

Feature

- -20V/-3A, $R_{DS(ON)} = 120m\Omega(MAX) @V_{GS} = -4.5V$.
 $R_{DS(ON)} = 150m\Omega(MAX) @V_{GS} = -2.5V$.
- Super High dense cell design for extremely low $R_{DS(ON)}$
- Reliable and Rugged
- SOT-23 for Surface Mount Package

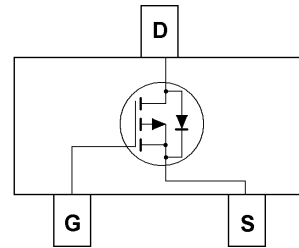

Applications

- Power Management
Portable Equipment and Battery Powered Systems.

Absolute Maximum Ratings $T_A=25^{\circ}C$ Unless Otherwise noted

Parameter	Symbol	Limit	Units
Drain-Source Voltage	V_{DS}	-20	V
Gate-Source Voltage	V_{GS}	± 10	V
Drain Current-Continuous	I_D	-3	A

Electrical Characteristics $T_A=25^{\circ}C$ Unless Otherwise noted

Parameter	Symbol	Test Conditions	Min	Typ.	Max	Units
Off Characteristics						
Drain to Source Breakdown Voltage	BVDSS	$V_{GS}=0V, I_D=-250\mu A$	-20	-	-	V
Zero-Gate Voltage Drain Current	I_{DSS}	$V_{DS}=-20V, V_{GS}=0V$	-	-	-1	μA
Gate Body Leakage Current, Forward	I_{GSSF}	$V_{GS}=10V, V_{DS}=0V$	-	-	100	nA
Gate Body Leakage Current, Reverse	I_{GSSR}	$V_{GS}=-10V, V_{DS}=0V$	-	-	-100	nA
On Characteristics						
Gate Threshold Voltage	$V_{GS(th)}$	$V_{GS}=V_{DS}, I_D=-250\mu A$	-0.4	-	-1.0	V
Static Drain-source On-Resistance	$R_{DS(ON)}$	$V_{GS}=-4.5V, I_D=-3.0A$	-	--	120	$m\Omega$
		$V_{GS}=-2.5V, I_D=-2.0A$	-	--	150	$m\Omega$
Drain-Source Diode Characteristics and Maximum Ratings						
Drain-Source Diode Forward Voltage	VSD	$V_{GS}=0V, I_S=-1.25A$			-1.2	V

Typical Characteristics

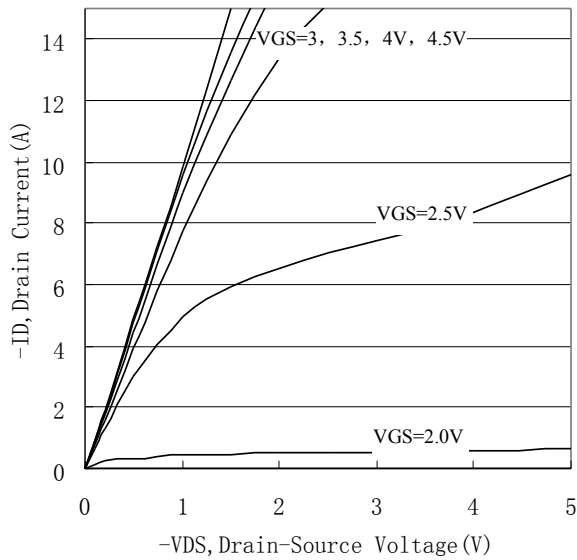

Figure 1. Output Characteristics

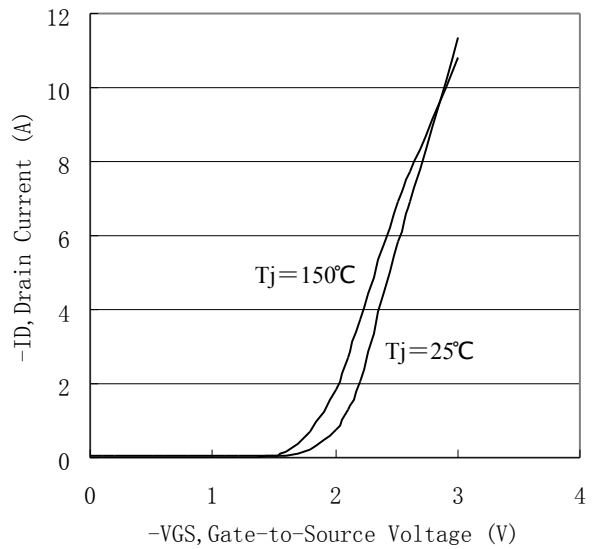

Figure 2. Transfer Characteristics

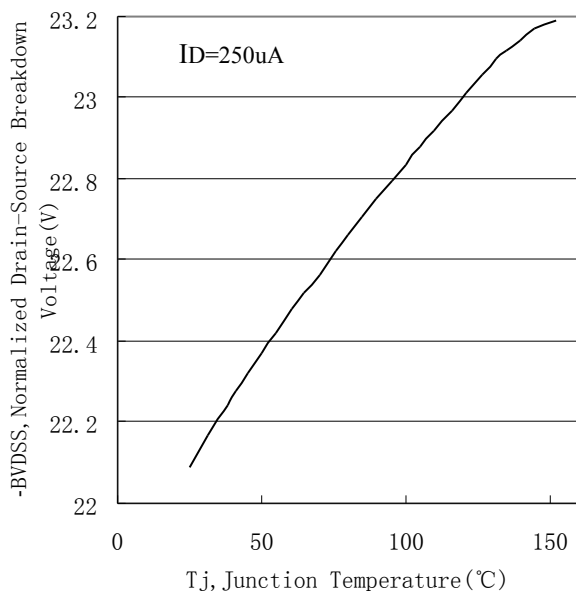

Figure 3. Breakdown Voltage Variation with Temperature

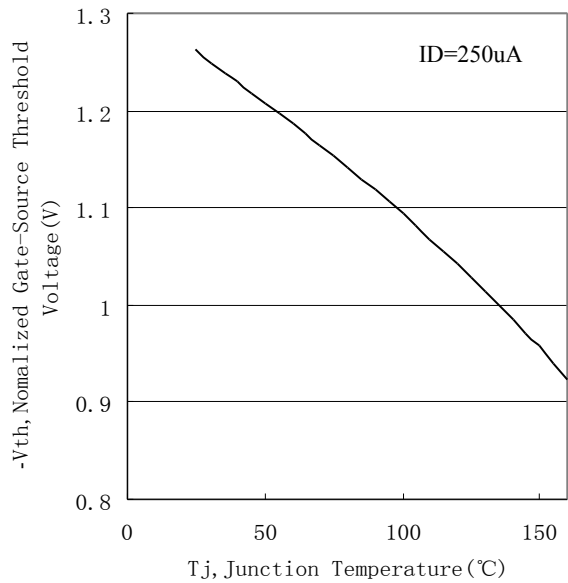

Figure 4. Gate Threshold Variation with Temperature

Typical Characteristics

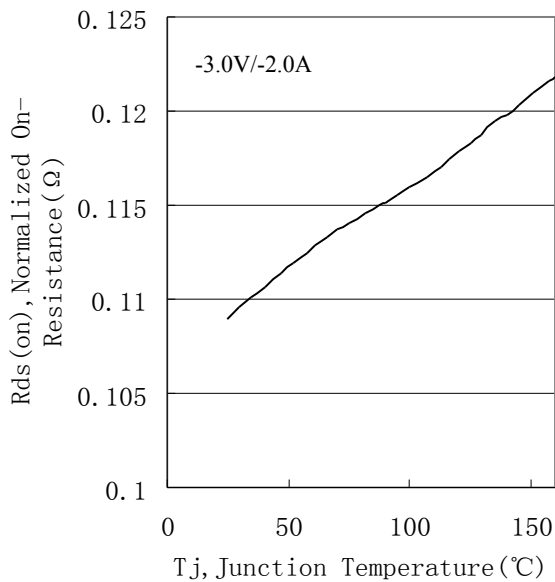

Figure 5. On-Resistance Variation with Temperature

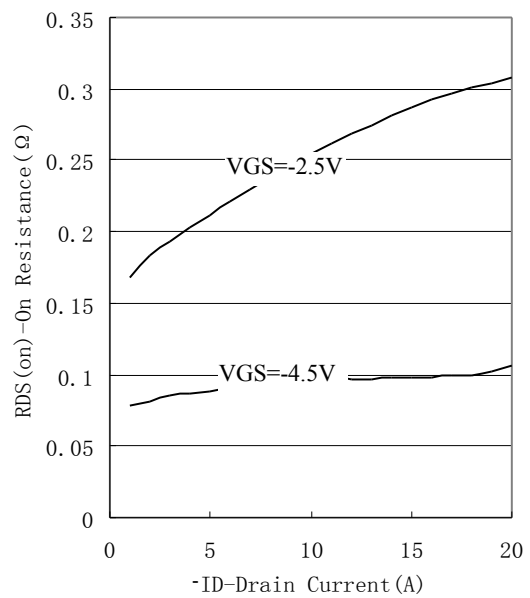

Figure 6. On-Resistance vs. Drain Current

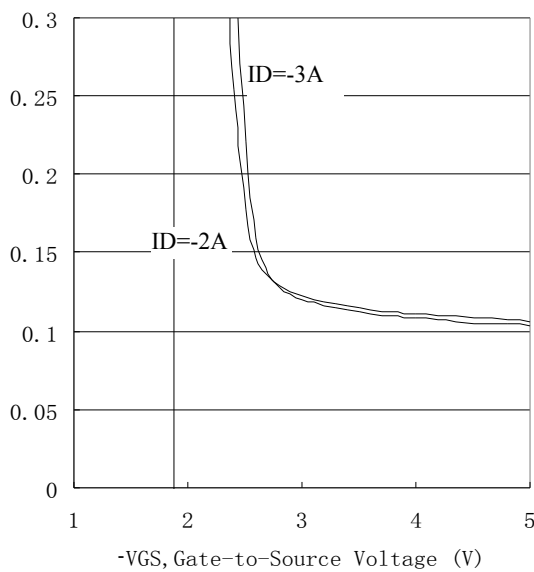

Figure 7. On-Resistance vs. Gate-to-Source Voltage

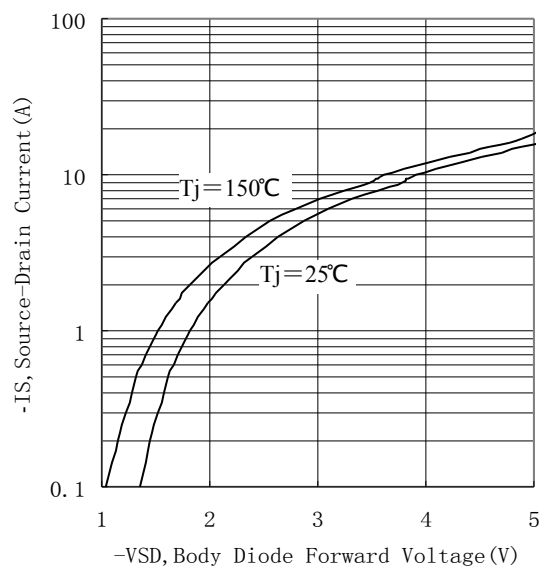
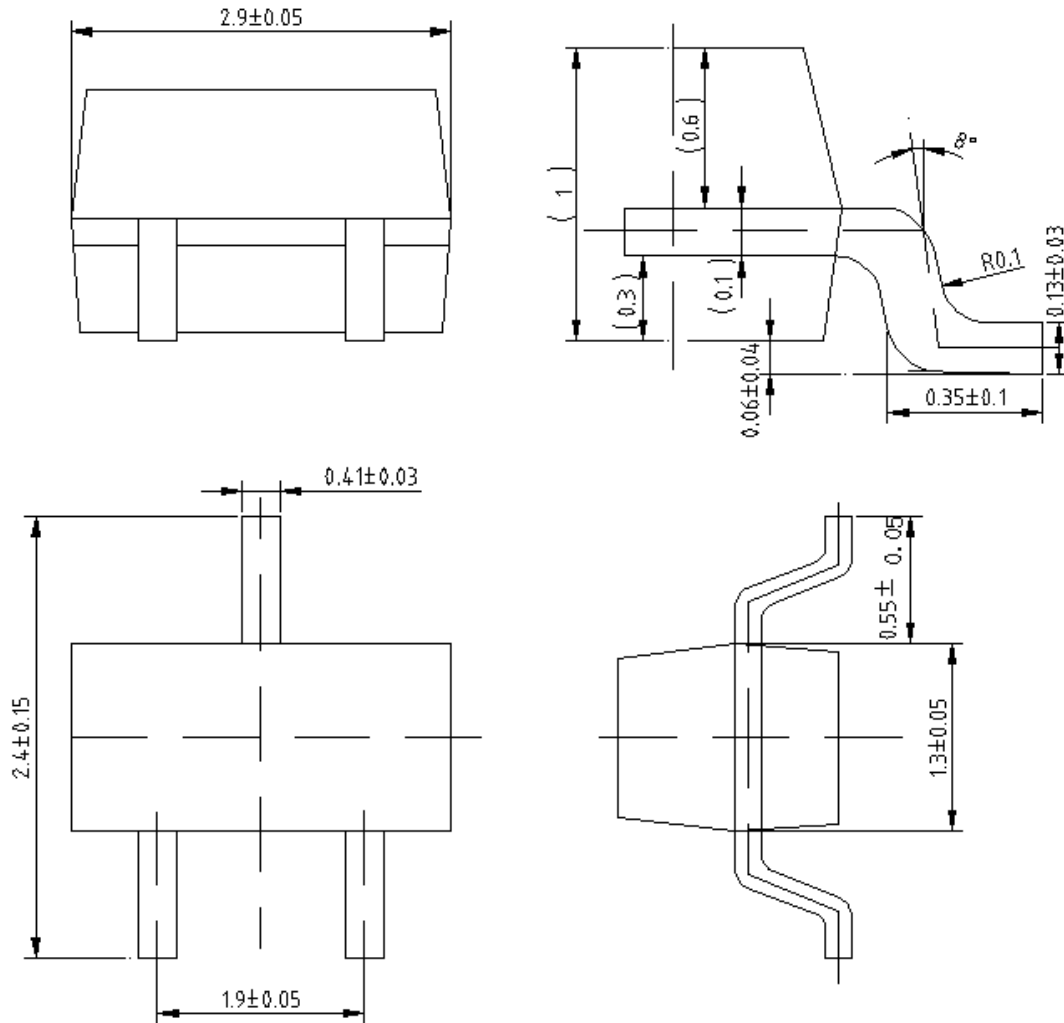

Figure 8. Source-Drain Diode Forward

Package Outline Dimensions (UNIT: mm)

SOT-23



SOT-23 Carrier Tape

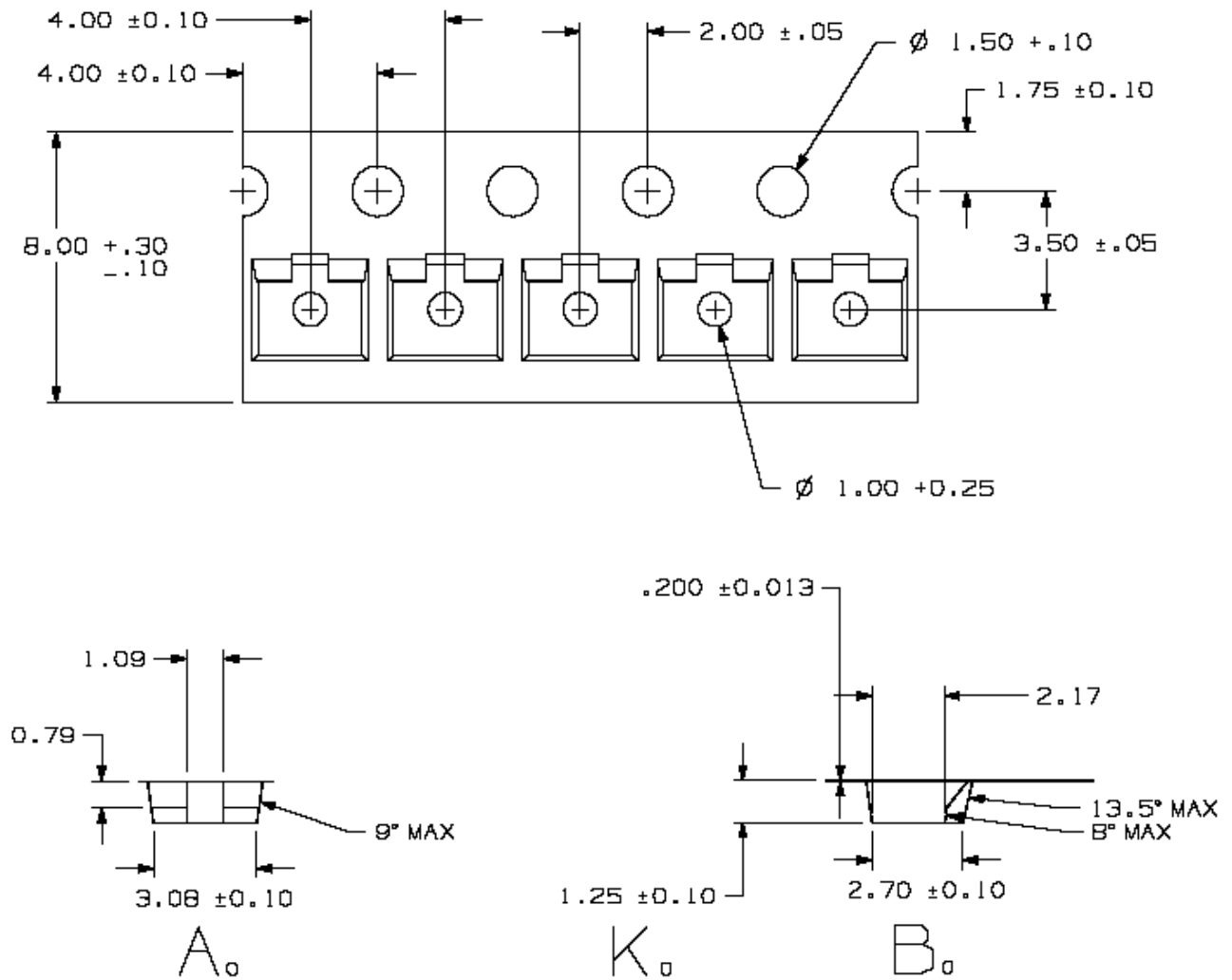

SOT-23 Carrier Reel

